

# Turmdrehkran

Tower Crane / Grue à tour / Gru a torre  
Grúa torre / Guindaste de torre

# 90 EC-B 6 FR.tronic®

**90 EC-B 6**

▶ **90 EC-B 6 FR.tronic®**

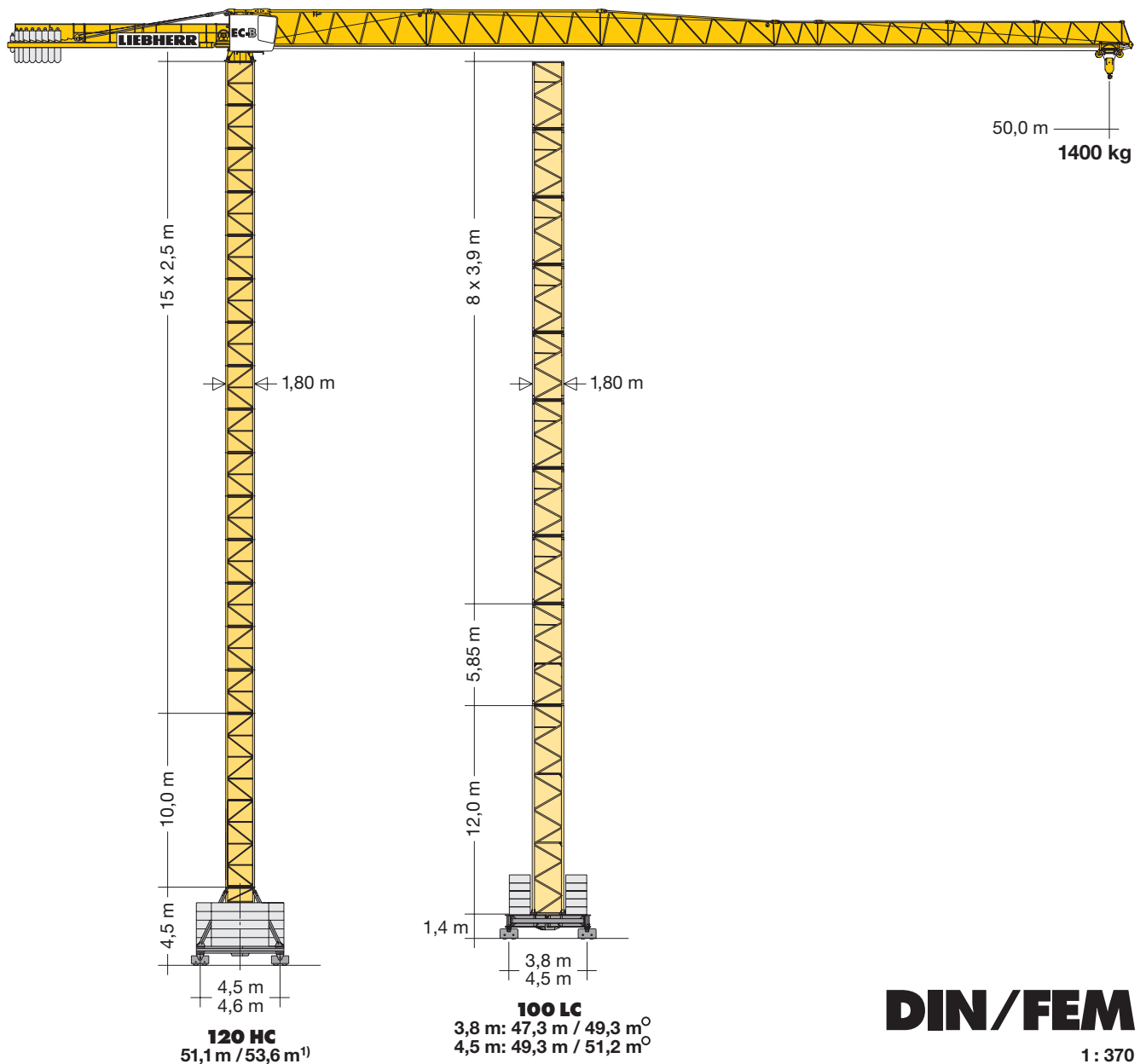

**DIN/FEM**

1: 370

# LIEBHERR

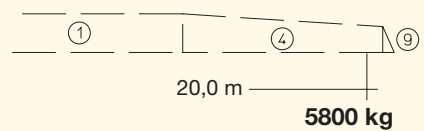
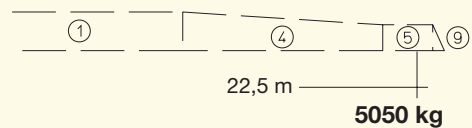
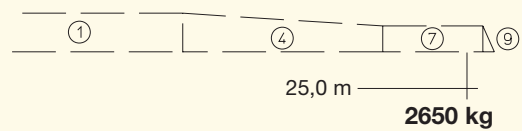
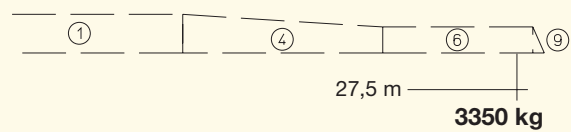
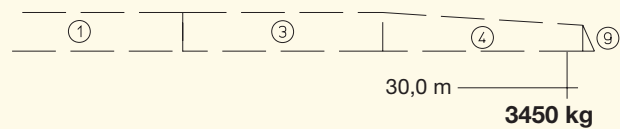
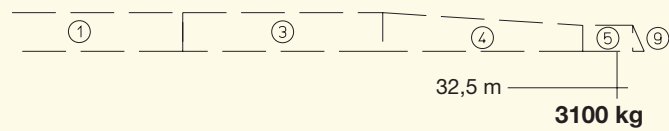
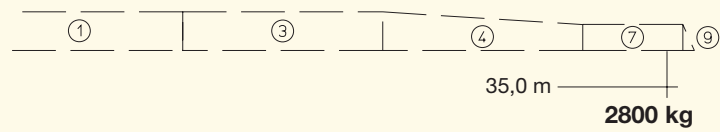
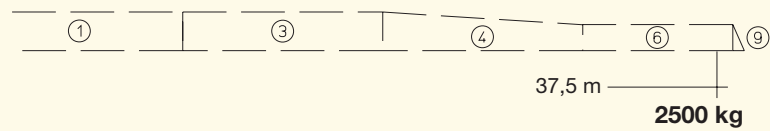
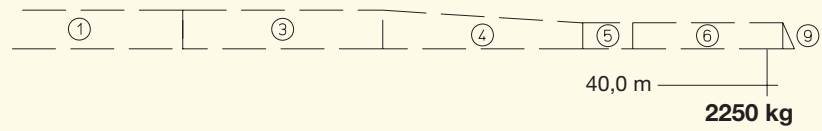
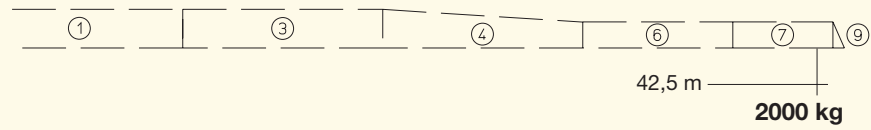
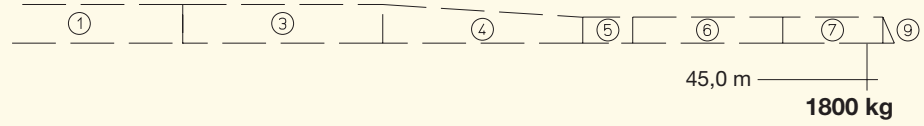
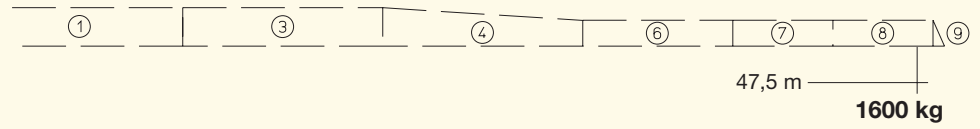
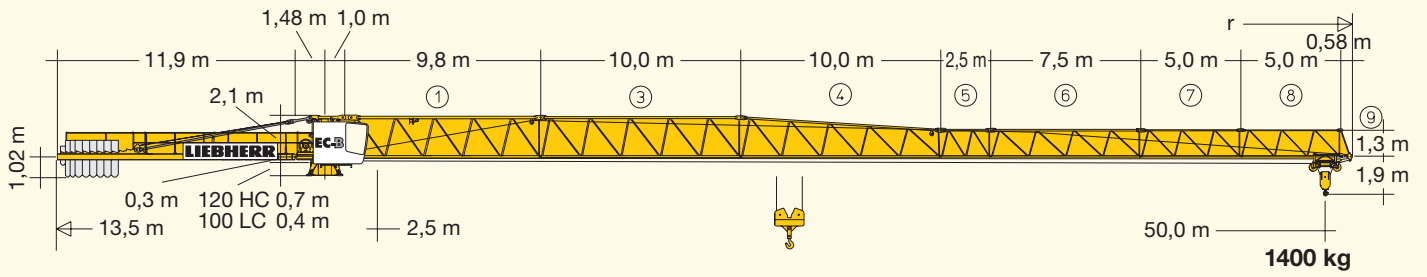

## 90 EC-B 6 FR.tronic®

m	r	m/kg	m/kg														
			15,0	17,5	20,0	22,5	25,0	27,5	30,0	32,5	35,0	37,5	40,0	42,5	45,0	47,5	50,0
50,0	(r = 51,5)	2,5 - 15,4 6000	6000	5220	4480	3910	3460	3080	2770	2510	2280	2090	1920	1760	1630	1510	1400
47,5	(r = 49,0)	2,5 - 16,1 6000	6000	5460	4700	4110	3630	3240	2920	2640	2410	2200	2020	1870	1730	1600	
45,0	(r = 46,5)	2,5 - 16,6 6000	6000	5660	4870	4260	3770	3360	3030	2750	2500	2290	2110	1950	1800		
42,5	(r = 44,0)	2,5 - 16,9 6000	6000	5790	4990	4360	3860	3450	3110	2820	2570	2350	2170	2000			
40,0	(r = 41,5)	2,5 - 17,5 6000	6000	5980	5150	4510	3990	3570	3220	2920	2670	2440	2250				
37,5	(r = 39,0)	2,5 - 17,8 6000	6000	6000	5260	4600	4080	3650	3290	2990	2730	2500					
35,0	(r = 36,5)	2,5 - 18,2 6000	6000	6000	5390	4720	4180	3740	3380	3070	2800						
32,5	(r = 34,0)	2,5 - 18,3 6000	6000	6000	5440	4770	4230	3780	3410	3100							
30,0	(r = 31,5)	2,5 - 18,5 6000	6000	6000	5500	4820	4270	3820	3450								
27,5	(r = 29,0)	2,5 - 16,5 6000	6000	5640	4850	4240	3750	3350									
25,0	(r = 26,5)	2,5 - 12,4 6000	4850	4070	3480	3020	2650										
22,5	(r = 24,0)	2,5 - 19,3 6000	6000	6000	5760	5050											
20,0	(r = 21,5)	2,5 - 19,4 6000	6000	6000	5800												

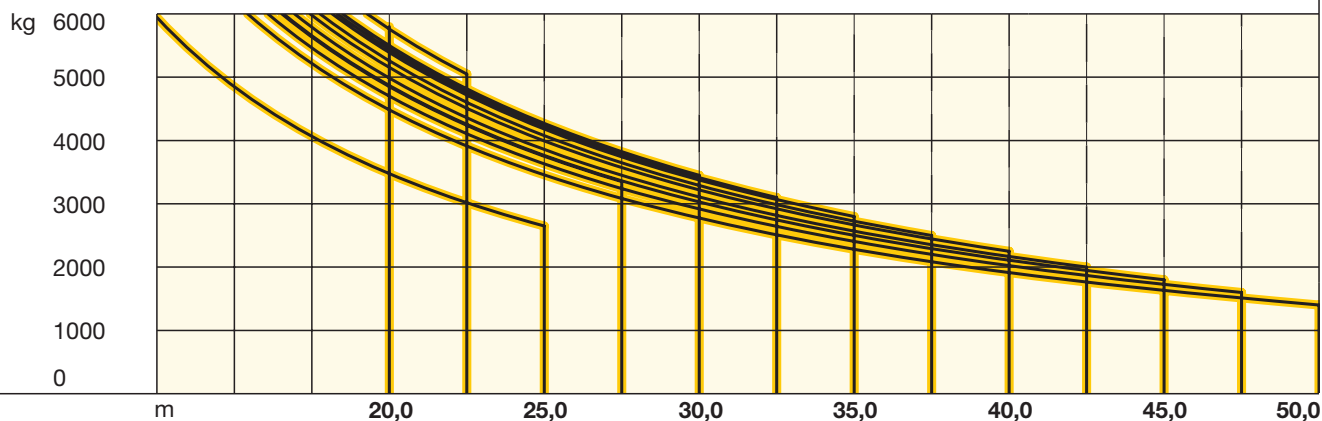

		100 LC												
3,9m	3,9m + 5,85m	5,85m	11,7m											
11				43,5°	-	-	43,7°	-	43,8°	-	43,1°	-	42,0°	-
10	9+1	7		41,6	-	-	41,8	-	41,9	-	41,2	-	40,0	-
	8+1			39,6	-	51,2°	39,8	-	39,9	-	39,2	-	38,1	-
9				37,7	49,3°	49,3	37,9	49,5	38,0	49,6	37,3	50,8°	36,1	50,0°
	7+1	6	3	35,7	47,3	47,3	35,9	47,5	36,0	47,6	35,3	46,9	34,2	46,1
8				33,8	45,4	45,4	34,0	45,6	34,1	45,7	33,4	45,0	32,2	44,2
	6+1	5		31,8	43,4	43,4	32,0	43,6	32,1	43,7	31,4	43,0	30,3	42,2
7				29,9	41,5	41,5	30,1	41,7	30,2	41,8	29,5	41,1	28,3	40,3
	5+1			27,9	39,5	39,5	28,1	39,7	28,2	39,8	27,5	39,1	26,4	38,3
6				26,0	37,6	37,6	26,2	37,8	26,3	37,9	25,6	37,2	24,4	36,4
	4+1	4	2	24,0	35,6	35,6	24,2	35,8	24,3	35,9	23,6	35,2	22,5	34,4
5				22,1	33,7	33,7	22,3	33,9	22,4	34,0	21,7	33,3	20,5	32,5
	3+1	3		20,1	31,7	31,7	20,3	31,9	20,4	32,0	19,7	31,3	18,6	30,5
4				18,2	29,8	29,8	18,4	30,0	18,5	30,1	17,8	29,4	16,6	28,6
	2+1			16,2	27,8	27,8	16,4	28,0	16,5	28,1	15,8	27,4	14,7	26,6
3				14,3	25,9	25,9	14,5	26,1	14,6	26,2	13,9	25,5	12,7	24,7
	1+1	2	1	12,3	23,9	23,9	12,5	24,1	12,6	24,2	11,9	23,5	10,8	22,7
2				10,4	22,0	22,0	10,6	22,2	10,7	22,3	10,0	21,6	8,8	20,8
	0+1	1		8,4	20,0	20,0	8,6	20,2	8,7	20,3	8,0	19,6	6,9	18,8
1				6,5	18,1	18,1	6,7	18,3	6,8	18,4	6,1	17,7	4,9	16,9
0	0	0	0	4,5	16,1	16,1	4,7	16,3	4,8	16,4	4,1	16,7	3,0	14,9
				-	12,2	12,2	-	12,4	-	12,5	-	11,8	-	11,0

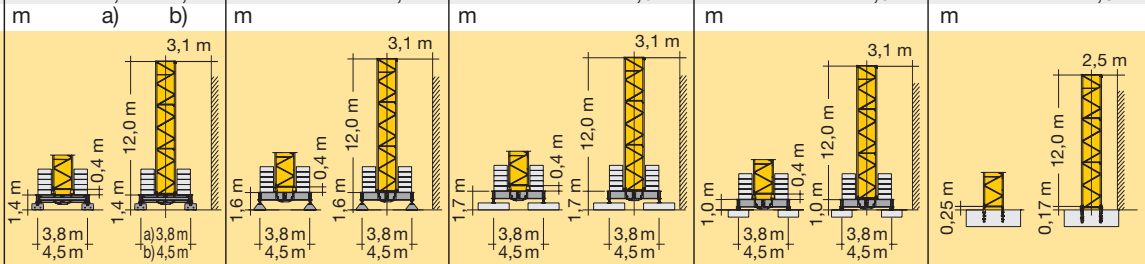

○ = Ohne Kabine. / Without cabin. / Sans cabine. / Senza cabina. / Sin cabina. / Sem cabine.

Weitere Hubhöhen sowie Klettern auf Anfrage. / Further hoist heights and climbing on request. / Hauteurs sous crochet plus élevées et hissage sur demande. / Altre altezze di sollevamento come pure telescopaggio, su richiesta. / Para alturas bajo gancho superiores y trepado, consultar. / Outras alturas de elevação e ascensionamento, mediante consulta.

		120 HC									
16	50,5 <sup>1)</sup>	53,6 <sup>1)</sup>	50,0 <sup>1)</sup>	53,1 <sup>1)</sup>	46,2 <sup>1)</sup>	49,3 <sup>1)</sup>	47,7 <sup>1)</sup>	50,8 <sup>1)</sup>	47,5 <sup>1)</sup>	50,6 <sup>1)</sup>	
15	48,0 <sup>2) 3)</sup>	51,1 <sup>2) 3)</sup>	47,5 <sup>2) 3)</sup>	50,6 <sup>2) 3)</sup>	43,7 <sup>2) 3)</sup>	46,8 <sup>2) 3)</sup>	45,2 <sup>2) 3)</sup>	48,3 <sup>2) 3)</sup>	45,0 <sup>2) 3)</sup>	48,1 <sup>2) 3)</sup>	
14	45,5 <sup>4)</sup>	48,6 <sup>4)</sup>	45,0 <sup>4)</sup>	48,1 <sup>4)</sup>	41,2 <sup>4)</sup>	44,3 <sup>4)</sup>	42,7 <sup>4)</sup>	45,8 <sup>4)</sup>	42,5 <sup>4)</sup>	45,6 <sup>4)</sup>	
13	43,0	46,1	42,5	45,6	38,7	41,8	40,2	43,3	40,0	43,1	
12	40,5	43,6	40,0	43,1	36,2	39,3	37,7	40,8	37,5	40,6	
11	38,0	41,1	37,5	40,6	33,7	36,8	35,2	38,3	35,0	38,1	
10	35,5	38,6	35,0	38,1	31,2	34,3	32,7	35,8	32,5	35,6	
9	33,0	36,1	32,5	35,6	28,7	31,8	30,2	33,3	30,0	33,1	
8	30,5	33,6	30,0	33,1	26,2	29,3	27,7	30,8	27,5	30,6	
7	28,0	31,1	27,5	30,6	23,7	26,8	25,2	28,3	25,0	28,1	
6	25,5	28,6	25,0	28,1	21,2	24,3	22,7	25,8	22,5	25,6	
5	23,0	26,1	22,5	25,6	18,7	21,8	20,2	23,3	20,0	23,1	
4	20,5	23,6	20,0	23,1	16,2	19,3	17,7	20,8	17,5	20,6	
3	18,0	21,1	17,5	20,6	13,7	16,8	15,2	18,3	15,0	18,1	
2	15,5	18,6	15,0	18,1	11,2	14,3	12,7	15,8	12,5	15,6	
1	13,0	16,1	12,5	15,6	8,7	11,8	10,2	13,3	10,0	13,1	
0	a) 10,5	b) 13,6	a) 10,0	b) 13,1	a) 6,2	b) 9,3	a) 7,7	b) 10,8	a) 7,5	b) 10,6	

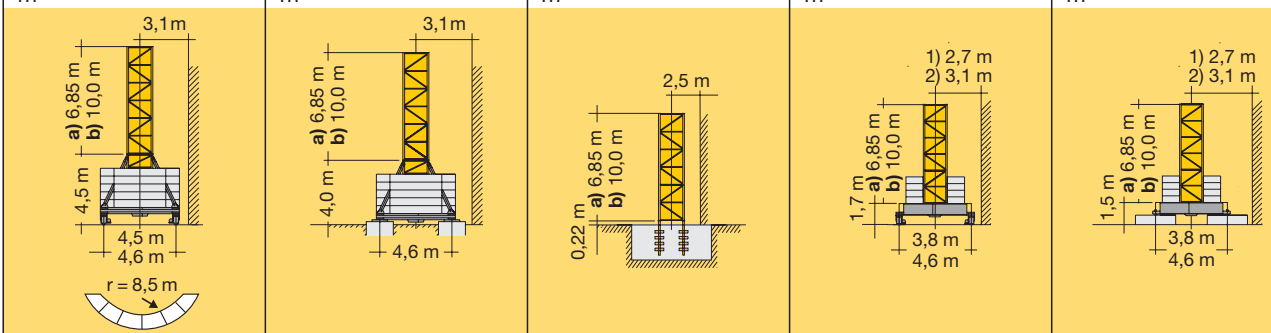

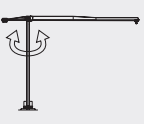
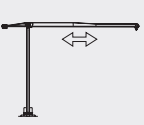
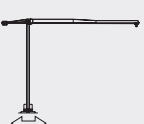
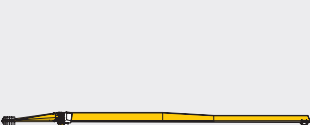
	0 ↔ U/min 0,8 sl./min tr./min	7,5 kW FU
	0 ↔ 63,0 m/min 0 ↔ 80,0 m/min	3,0 kW FU 5,4 kW FU
	25,0 m/min	2 x 4,0 kW
	<b>kVA</b>	30 kW FU 33,0

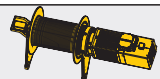
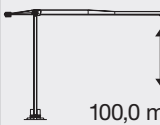
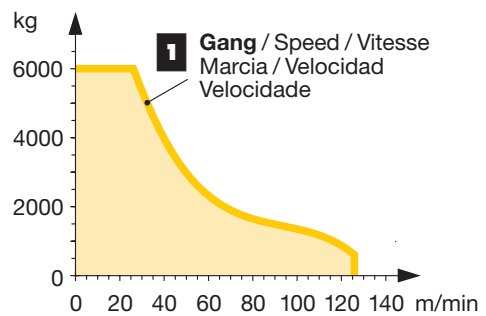

















	↔ <b>stufenlos</b> / stepless / régl. continu régl. progressive / sin escalones / sem degraus kg m/min
30 kW FU WIW 240 MZ 403	
	5 <b>Lagen</b> Layers Couches Strati Camadas Capas
100,0 m	<b>1</b> 6000 0 ↔ 26 550 0 ↔ 126
max. 174,0 m**	
 <p><b>1</b> <b>Gang</b> / Speed / Vitesse Marcia / Velocidad Velocidade</p>	

\*\* **Weitere Hublastdaten: siehe Betriebsanleitung.** / Further hoist load data: see instruction manual. / Autres données de la charge de levage: voir manuel d'instruction. / Altri dati sui carichi sollevati: consultare il manuale d'istruzione. / Alturas bajo gráncho superiores según manual. / Outras tabelas de carga: consultar manual de instruções.

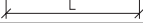
## Kolli-Liste

Packing List / Liste de colisage / Lista dei colli / Lista de contenido / Lista de embalagem

Montagegewichte: siehe Betriebsanleitung. / Erection weights: see instruction manual. / Poids de montage: voir manuel de service. / Pesos de montaje: vedasi le istruzioni sull'uso. / Peso para el montaje: según manual. / Pesos de montagem: vejäm-se es instruções p. uso.

<b>Kranoberteil</b>		Upper part of crane / Partie supérieure de grue / Parte superiore della gru	L (m)	B (m)	H (m)	kg*		
Pos. Item Rep. Voce Pos. Ref.	Anz. Qty. Qta. Cant. Cant.	<b>Drehbühne mit Podesten</b> / Slewing platform with platforms Plate-forme tournante avec plates-formes / Piattaforma girevole con pedana / Plataforma giratoria con plataforma Plataforma giratória com plataforma			2,71	2,90	2,58	6220
2	1	<b>Drehbühne</b> / Slewing platform Ensemble mât cabine / Piattaforma girevole / Conjunto plataforma de giro Plataforma giratória compl.			2,71	2,25	2,58	5940
3	1	<b>Podeste</b> / Platforms Plates-formes / Pedana Plataformas / Plataformas			2,33 2,40 2,33	0,50 1,04 0,65	1,36 1,33 1,36	120 150 120
4	1	<b>Kabine</b> / Cabin Cabine / Cabina Cabina / Cabina			1,35	2,82	2,28	610
5	1	<b>Gegenausleger</b> / Counter-jib Contre-flèche / Contrabaccio Contra-pluma / Contra-lança			11,98	1,40	0,81	2720
6	1	<b>Podeste Gegenausleger</b> / Counter-jib platforms Plates-formes de contre-flèche / Ballatoi controfreccia Plataforma contra-pluma / Plataforma contra-lança			4,00	0,69	1,35	180
7	1	<b>Ausleger-Anlenkstück</b> / Jib heel section Pied de flèche / Settore articolato di braccio Pluma tramo primero / Base articulada de lança			10,01	1,34	2,23	① 2010
8	1	<b>Ausleger-Zwischenstück</b> / Intermediate jib section Élément intermédiaire de flèche / Spezzone di braccio Tramo intermedio pluma / Peça suplementar da lança			10,26 2,72 7,71 5,19 5,17	1,20 1,20 1,20 1,20 1,20	2,14 1,48 1,48 1,46 1,45	③ 1180 ⑤ 200 ⑥ 500 ⑦ 230 ⑧ 200
9	1	<b>Ausleger-Zwischenstück</b> / Intermediate jib section Élément intermédiaire de flèche / Spezzone di braccio Tramo intermedio pluma / Peça suplementar da lança			10,22	1,20	2,08	④ 850

Pos. Item Rep. Voce Pos. Ref.	Anz. Qty. Qta. Cant. Cant.				L (m)	B (m)	H (m)	kg*	
10	1	<b>Ausleger-Kopfstück</b> / Jib head section Pointe de flèche / Punta freccia Tramo punta de pluma / Cabeça de lança						80	
11	1	<b>Laufkatze</b> / Trolley Chariot / Carrello Carrito / Carrinho						530	
12	1	<b>Fahrkorb</b> / Maintenance cage Nacelle d'entretien / Cestello di manutenzione Plataforma de mantenimiento						35	
<b>Turm</b> Tower / Mât / Torre Torre / Torre									
13	1	<b>Grundturmstück</b> / Base tower section Mât de base / Elemento di torre base Tramo base / Peça de base de torre							
					100 LC	12,00	2,03	3820	
					120 HC	6,85	1,80	2610	
					120 HC	10,00	1,80	3530	
					3,90 m	100 LC	4,17	1,80	1190
					5,85 m	100 LC	6,12	1,80	1620
					11,70 m	100 LC	11,97	1,80	2930
						120 HC	2,50	1,80	1090
						120 HC	5,00	1,80	1830
						120 HC	10,00	1,80	3430
						120 HC	12,50	1,80	4200
14	1	<b>Turmstück</b> / Tower section Elément de mât / Elemento di torre Tramo torre / Torre							
<b>Klettereinrichtung</b> Climbing equipment / Equipement de télescopage / Attrezzatura per allungamento della gru Equipo de trepado / Acessórios p. subida no edifício									
15	1	<b>Führungsstück kpl.</b> / Guide section cpl. Cage télescopique cpl. / Gabbia de sopraelevazione compl. / Torre de montaje completa / Peça de guia compl.							
					100 LC	8,74	2,27	3130	
					120 HC	6,45	2,10	3500	
					120 HC	9,60	2,10	4440	
16	1	<b>Führungsstück Turmstück</b> / Tower guide section / Elément de mât télescopique Gabbia de sopraelevazione / Peça de guia Tramo torre de montaje							
					100 LC	4,17	2,26	1440	
17	1	<b>Kletterturmstück</b> / Climbing tower section Elément de hissage de mât / Elemento torre di telescopaggio / Tramo de trepado Tramo de telescopagem							
					120 HC	2,75	2,20	1450	
18	1	<b>Hydraulikanlage, Stütz- und Klettertraverse</b> / Hydraulic unit, supporting and climbing cross members / Système hydraul. avec traverses d'appui et de télescop. / Sist. idraul., traversa di appoggio e allugam. gru / Sistema hidráulico con traviesa de apoyo y trepado / Instalação hidráulica, tavessa de apoio e subida							
					100 LC	2,00	0,90	640	
					120 HC	2,87	2,12	1050	
<b>Fundamentkreuz</b> Cruciform base / Châssis en croix / Carro della gru Carro de guindaste / Base cruciforme									
19	1	<b>Tragholm I</b> / Arm I Longeron I / Longherone I Braço I / Travessa I							
					(3,8 m) 100 LC	5,68	0,71	2090	
					(4,5 m) 100 LC	6,67	0,71	2190	
					120 HC	7,12	0,78	950	
20	1	<b>Tragholm II</b> / Arm II Longeron II / Longherone II Braço II / Travessa II							
					(3,8 m) 100 LC	5,68	0,78	1870	
					(4,5 m) 100 LC	6,67	0,78	1970	
					120 HC	3,45	0,56	408	
21	2	<b>Fahrschemel mit Antrieb</b> / Rail bogie with drive / Bogie moteur / Telajo con gruppa propulsore / Caja rodillo motriz Quadra sem grupa de propulsão							
					100 LC	1,31	0,66	630	
					120 HC	1,38	0,88	900	
22	2	<b>Fahrschemel ohne Antrieb</b> / Rail bogie without drive / Bogie fou / Telajo senza gruppa propulsore / Caja rodillo conducido Quadra com grupa de propulsão							
					100 LC	1,04	0,33	330	
					120 HC	1,17	0,60	860	

\* Einzelgewichte. / Single weights. / Poids individuels. / Pesì di componenti. / Pesos unitarios. / Pesos de peças componentes.

**Konstruktionsänderungen vorbehalten!**  
Subject to alterations! / Sous réserves de modifications!  
Si fa riserva di modifiche! / ¡Sujeto a modificaciones!  
Salvo modificação da construção!

**Sämtliche Angaben erfolgen ohne Gewähr.** / This information is supplied without liability.  
Ces renseignements sont sans garantie. / Le indicazioni contenute si intendono salvo errori ed omissioni.  
Declinamos toda responsabilidad derivada de la información proporcionada. / Declinamos qualquer  
responsabilidade quanto à informação fornecida.

121 P – 5162 H1 B3 DIN 15018 • BGL C.0.10.0090 / FEM (Section 1) – Krangruppe A3 • 04.07 / 6

Printed in Germany.

Liebherr-Werk Biberach GmbH  
Postfach 1663, D-88396 Biberach an der Riss  
☎ +49 73 51 41-0, Fax: +49 73 51 41 22 25  
www.liebherr.com, E-Mail: info.lbc@liebherr.com

Liebherr Industrias Metálicas, S.A.  
Polígono Industrial Agustinos, Apartado 4096, E-31014 Pamplona  
☎ +34-948-29 70 00, Fax +34-948-29 70 29  
www.liebherr.com, E-Mail: info.lim@liebherr.com

90 EC-B 6 FR.tronic® 6