

Turmdrehkran

Tower Crane / Grue à tour / Gru a torre / Grúa torre
Guindaste de torre / Башенный поворотный кран

420 EC-H 16 FR.tronic®

420 EC-H 16 Litronic®

420 EC-H 16 FR.tronic®
420 EC-H 16 Litronic®

420 EC-H 20 FR.tronic®
420 EC-H 20 Litronic®

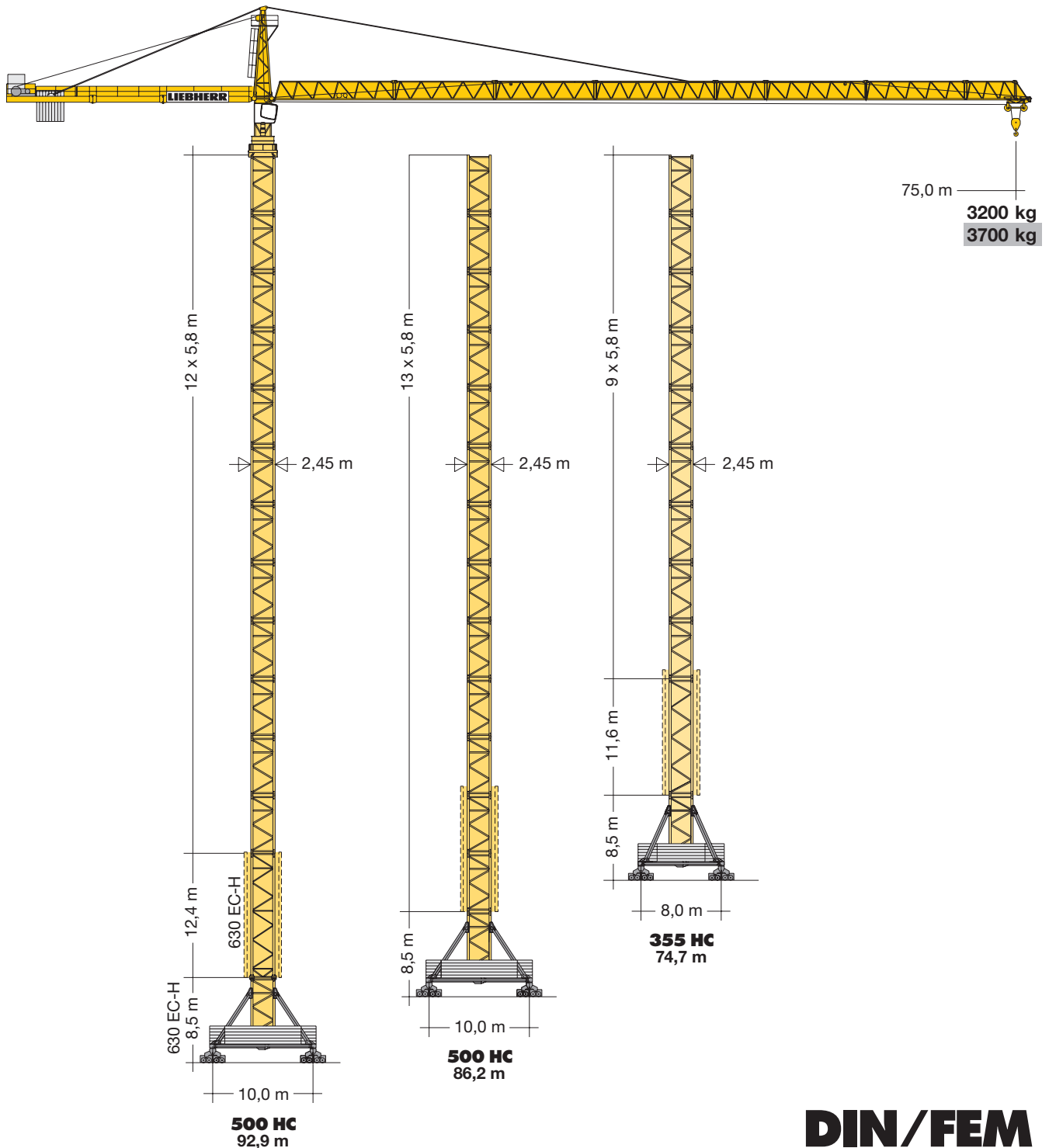

DIN/FEM

LIEBHERR

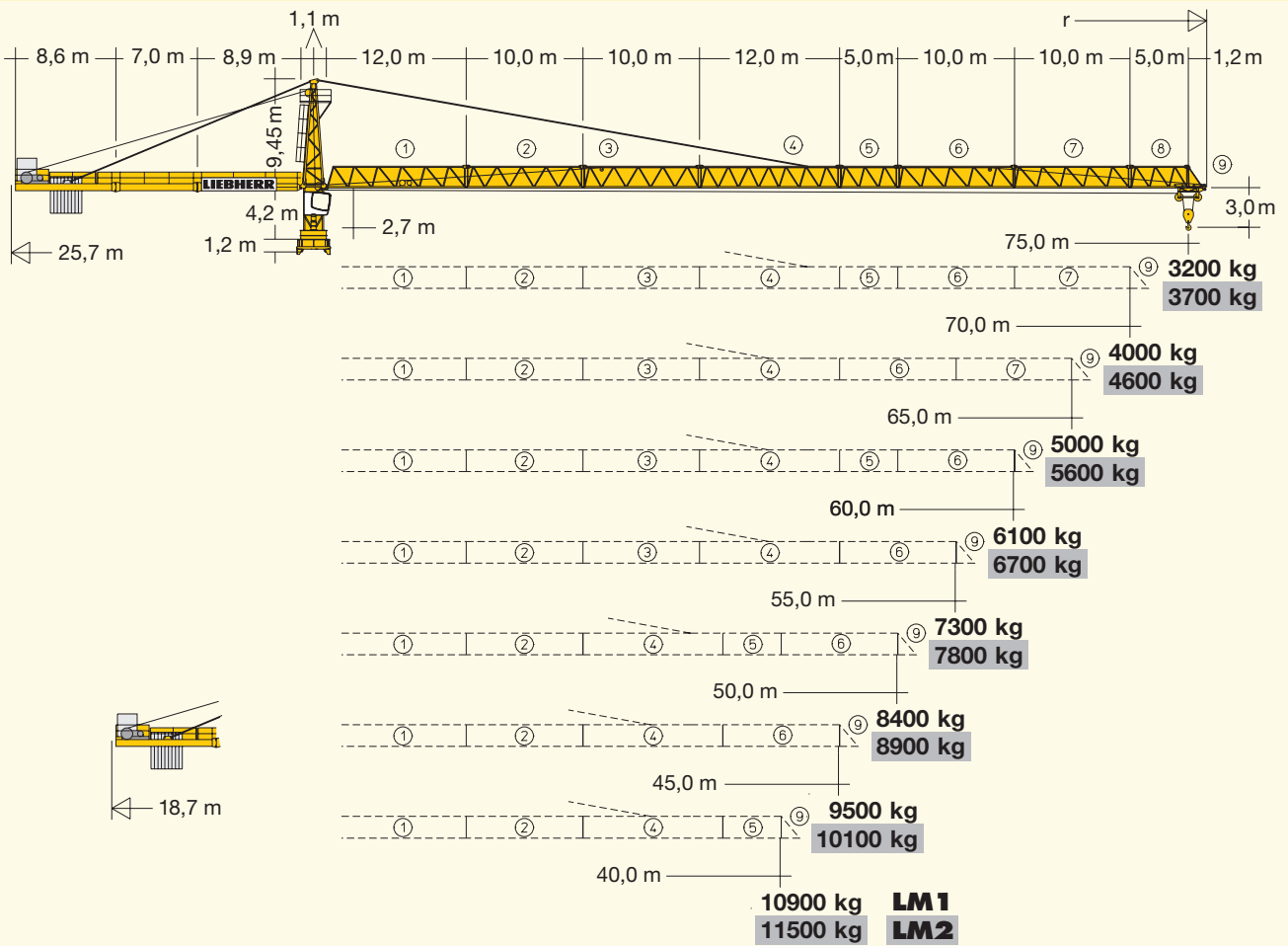

Hubhöhe Hoisting height / Hauteur sous crochet / Altezza di sollevamento
 Altura bajo gancho / Altura de montagem / Высота подъема

	355 HC		500 HC			
13	-	-	78,2*	86,2*	-	-
12	-	-	72,4	80,4	84,7*	92,9*
11	-	-	66,6	74,6	78,9	87,1
10	72,4*	-	60,8	68,8	73,1	81,3
9	66,6	74,7*	55,0	63,0	67,3	75,5
8	60,8	68,9	49,2	57,2	61,5	69,7
7	55,0	63,1	43,4	51,4	55,7	63,9
6	49,2	57,3	37,6	45,6	49,9	58,1
5	43,4	51,5	31,8	39,8	44,1	52,3
4	37,6	45,7	26,0	34,0	38,3	46,5
3	31,8	39,9	20,2	28,2	32,5	40,7
2	26,0	34,1	14,4	22,4	26,7	34,9
1	20,2	28,3	8,6	16,6	20,9	29,1
0	14,4	22,5	2,8	10,9	15,1	23,3
	m	m	m		m	

* Weitere Hubhöhen, Auslegerlängen sowie Klettern im Gebäude auf Anfrage. / Further hoist heights and jib lengths as well as climbing inside the building on request. / Autres hauteurs sous crochet et longueurs de flèche ainsi que hissage dans le bâtiment sur demande. / Ulteriori altezze gancho, lunghezze braccio così come telescopaggio all'interno dell'edificio: su richiesta. / Para alturas bajo gancho superiores, otros alcances y trepado en el interior del edificio, consultar. / Outras alturas de elevação, comprimentos de lança e subida no edifício: sob consulta. / Другие высоты подъема, длины стрелы и самоподъем в здании – по запросу.

Ausladung und Tragfähigkeit

Radius and capacity / Portée et charge / Sbraccio e portata
Alcances y cargas / Alcance e capacidade de carga / Вылет и грузоподъемность

		420 EC-H 16 FR.tronic®														
m	r	m/kg	m/kg													
			22,0	25,0	28,0	31,0	34,0	37,0	40,0	45,0	50,0	55,0	60,0	65,0	70,0	75,0
75,0	(r=76,7)	2,7-20,7 16000	14950	12940	11370	10110	9070	8200	7460	6440	5630	4970	4410	3950	3550	3200
70,0	(r=71,7)	2,7-22,5 16000	16000	14220	12510	11130	10000	9050	8250	7150	6260	5540	4940	4440	4000	
65,0	(r=66,7)	2,7-24,3 16000	16000	15530	13690	12210	10990	9970	9110	7920	6970	6190	5550	5000		
60,0	(r=61,7)	2,7-26,2 16000	16000	16000	14880	13280	11970	10870	9940	8660	7630	6800	6100			
55,0	(r=56,7)	2,7-27,8 16000	16000	16000	15870	14180	12790	11620	10630	9270	8190	7300				
50,0	(r=51,7)	2,7-28,3 16000	16000	16000	16000	14460	13050	11870	10870	9500	8400					
45,0	(r=46,7)	2,7-28,3 16000	16000	16000	16000	14470	13060	11880	10870	9500						
40,0	(r=41,7)	2,7-28,3 16000	16000	16000	16000	14500	13090	11910	10900							

LM1

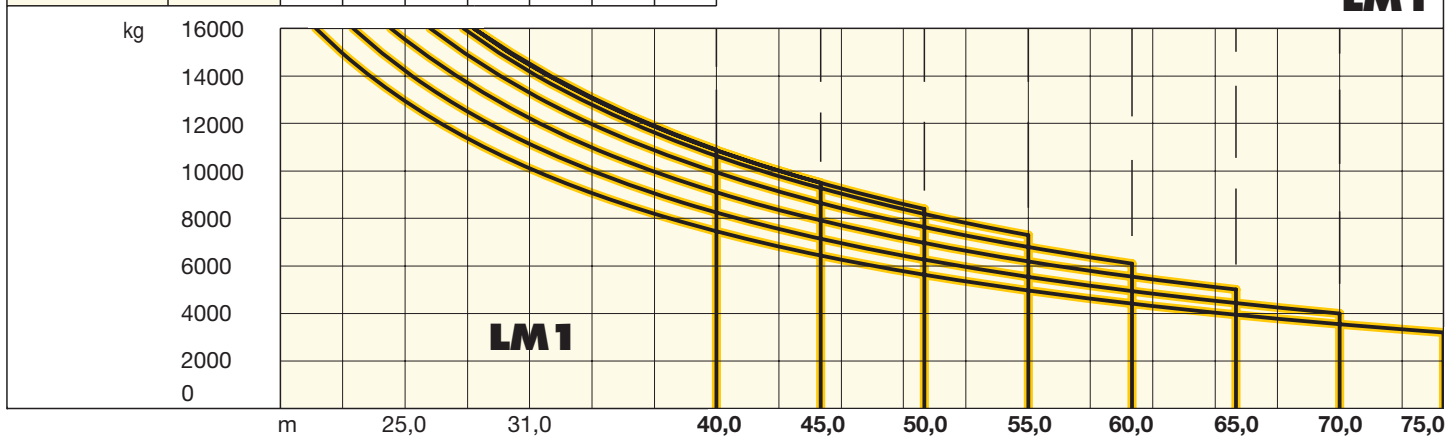

Antriebe FR.tronic®/Litronic®

Driving units / Mécanismes d'entraînement
Meccanismi / Mecanismos / Mecanismos / Приводы

↔ stufenlos / stepless / régl. continu
regl. progressiva / sin escalones / sem degraus
бесступенчатый

65 kW FU
WIW 280 MZ 404 5 **Lagen**
Layers
Couches
Avvolgimenti
Camadas
Capas
Слоёв

197,0 m

max. 393,0 m**

1	16000	0 ↔ 21
	3300	0 ↔ 72

↔ stufenlos / stepless / régl. continu
regl. progressiva / sin escalones / sem degraus
бесступенчатый

65 kW FU
WIW 280 VZ 405 5 **Lagen**
Layers
Couches
Avvolgimenti
Camadas
Capas
Слоёв

219,0 m

max. 437,0 m**

1	16000	0 ↔ 21
	3300	0 ↔ 73
2	9400	0 ↔ 34
	1100	0 ↔ 128

** Weitere Hublastdaten: siehe Betriebsanleitung. / Further hoist load data: see instruction manual. / Autres données de la charge de levage: voir manuel d'instruction. / Altri dati sui carichi sollevati: consultare il manuale d'istruzione. / Alturas bajo grancho superiores según manual. / Outras tabelas de carga: consultar manual de instruções. / Другие данные по весу поднимаемых грузов: см. инструкцию по эксплуатации.

Ausladung und Tragfähigkeit

Radius and capacity / Portée et charge / Sbraccio e portata
Alcances y cargas / Alcance e capacidade de carga / Вылет и грузоподъемность

		420 EC-H 16 Litronic®														
m	r	m/kg	m/kg													
			22,0	25,0	28,0	31,0	34,0	37,0	40,0	45,0	50,0	55,0	60,0	65,0	70,0	75,0
75,0	(r=76,7)	2,7-22,8 16000	16000	14450	12720	11320	10170	9210	8390	7280	6380	5650	5040	4520	4080	3700
70,0	(r=71,7)	2,7-24,9 16000	16000	15900	14020	12490	11240	10190	9300	8080	7110	6310	5640	5080	4600	
65,0	(r=66,7)	2,7-26,8 16000	16000	16000	15220	13580	12230	11100	10140	8830	7780	6920	6210	5600		
60,0	(r=61,7)	2,7-28,4 16000	16000	16000	16000	14540	13110	11910	10890	9490	8370	7460	6700			
55,0	(r=56,7)	2,7-29,5 16000	16000	16000	16000	15150	13660	12410	11350	9910	8750	7800				
50,0	(r=51,7)	2,7-29,9 16000	16000	16000	16000	15390	13880	12620	11550	10080	8900					
45,0	(r=46,7)	2,7-30,0 16000	16000	16000	16000	15430	13920	12650	11570	10100						
40,0	(r=41,7)	2,7-29,8 16000	16000	16000	16000	15330	13830	12570	11500							

LM1 + LM2

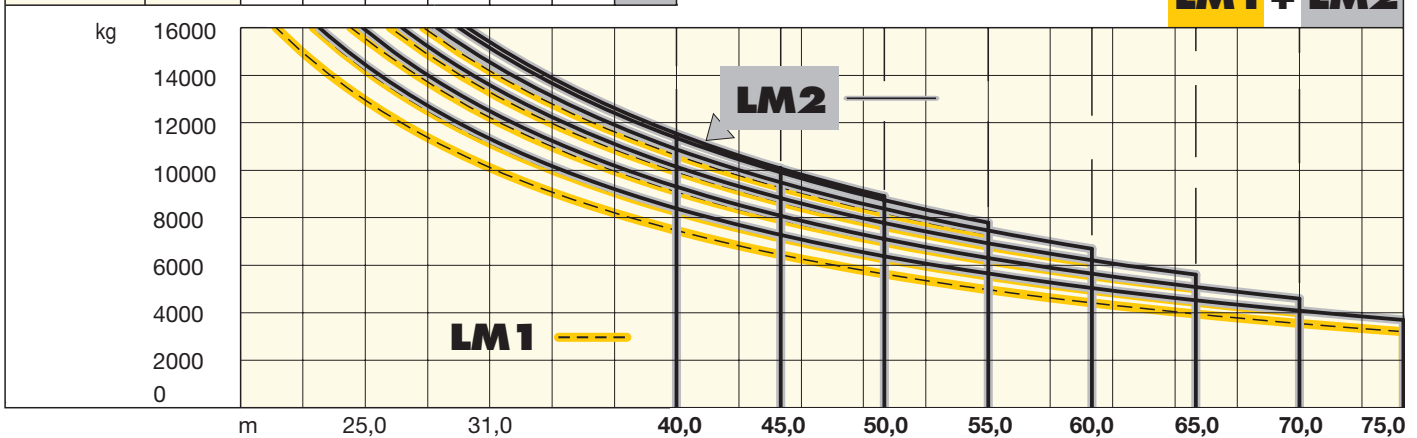

Antriebe FR.tronic®/Litronic®

Driving units / Mécanismes d'entraînement
Meccanismi / Mecanismos / Mecanismos / Приводы



110 kW FU
WIW 300 VZ 411

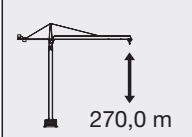

270,0 m
max. 437,0 m**

↔ **stufenlos** / stepless / régl. continu
régl. progressive / sin escalones / sem degraus
бесступенчатый

kg m/min

1	16000	0 ↔	35
	8000	0 ↔	65
2	9400	0 ↔	56
	4100	0 ↔	113
3	5200	0 ↔	94
	1700	0 ↔	188

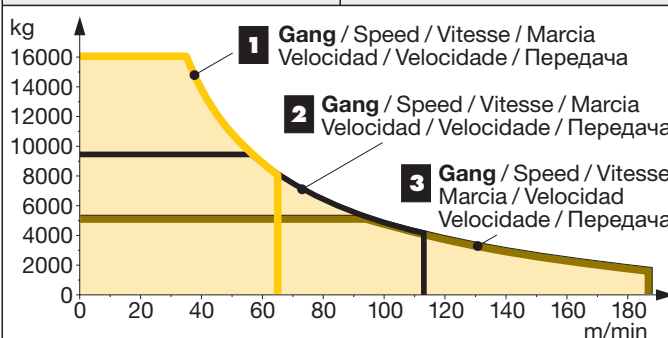

6 Lagen
Layers
Couches
Avvolgimenti
Camadas
Capas
Слоёв







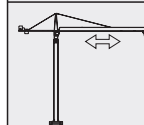
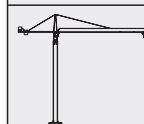





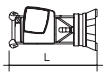

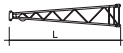



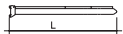



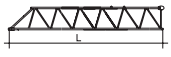

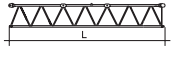









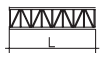

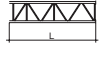
1 Gang / Speed / Vitesse / Marcia
Velocidad / Velocidade / Передача

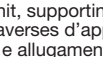



2 Gang / Speed / Vitesse / Marcia
Velocidad / Velocidade / Передача

3 Gang / Speed / Vitesse / Marcia
Velocidad / Velocidade / Передача

	0 ↔ 0,7 sl./min tr./min	2 x 7,5 kW FU
	0 ↔ 91,0 m/min	10,5 kW FU
	25,0 m/min	4 x 7,5 kW 500 HC (550 HC) 4 x 5,5 kW 355 HC (390 HC)
	kVA	65 kW FU 65 kW FU 110 kW FU 90,0 90,0 131,0

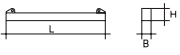
Litronic®: kVA reduzierbar bei zu geringer Netz-Anschlussleistung, siehe BAL. / kVA can be reduced in case of too little power of the mains, see instruction manual. / kVA peut être réduit en cas de trop faible puissance du réseau, voir manuel d'instruction. / kVA riducibili in caso di potenza di rete ridotta (si veda manuale uso e manutenzione) / kVA variable para potencia de red demasiado pequeña, ver Manual de instrucciones. / kVA reduzível no caso de capacidade da rede elétrica muito baixa, ver manual de instruções. / Количество kVA может быть сокращено до минимальной общей потребляемой мощности, см. инструкцию по эксплуатации.

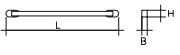
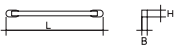
Kranoberteil		Upper part of crane / Partie supérieure de grue / Parte superiore della gru Parte superior grúa / Parte superior do guindaste / Верхняя часть крана	L (m)	B (m)	H (m)	kg*			
Pos. Anz. Item Qty. Rep. Qte. Voce Qta. Pos. Cant. Ref. Cant. Поз. Кол-во	1	Drehbühne kpl. / Slewing platform cpl. / Ensemble mât cabine cpl. / Piattaforma girevole compl. / Conjunto plataforma de giro / Plataforma giratória compl. / Поворотная платформа в сб.			6,14	2,87	3,18	15000	
2	1	Turmspitze / Tower head section / Porte-flèche / Testa porta-braccio / Cabeza de torre / Cabeça de apoio de lança / Оголовок башни			9,40	1,76	1,94	3450	
3	1	Gegenausleger-Kopfstück / Counter-jib head / Pointe de contre-flèche / Testa di controbraccio / Tramo punta de contrapluma / Cabeça de contra-lança / Концевая секция консоли противовеса			8,73	2,38	1,05	3740	
4	1	Gegenausleger-Anlenkstück / Counter-jib heel section / Pied de contre-flèche / Settore articolato di controbraccio / Tramo primero-contrapluma / Base articulada da contra-lança / Корневая секция консоли противовеса			9,08	1,93	1,05	3210	
5	1	Gegenausleger-Zwischenstück / Intermediate counter-jib section / Élément interm. de contre-flèche / Spezzone di controbraccio / Tramo intermedio de contrapluma / Peça suplementar da contra-lança / Промежуточная секция консоли противовеса			7,20	1,87	1,05	2720	
6	1	Ausleger-Anlenkstück / Jib heel section / Pied de flèche / Sezione articolata braccio / Pluma tramo primero / Base articulada de lança / Корневая секция стрелы			12,26	1,93	2,05	① 3700	
7	1	Ausleger-Zwischenstück / Intermediate jib section / Élément intermédiaire de flèche / Sezione intermedia braccio / Tramo intermedio pluma / Peça suplementar da lança / Промежуточная секция стрелы			10,28 10,30 12,33 5,38 10,34 10,27 5,21	1,76 1,76 1,76 1,76 1,76 1,76 1,76	1,99 1,98 1,99 1,97 1,96 1,94 1,94	② 2075 ③ 2040 ④ 2510 ⑤ 985 ⑥ 1500 ⑦ 1000 ⑧ 485	
8	1	Ausleger-Kopfstück / Jib head section / Pointe de flèche / Punta braccio / Tramo punta de pluma / Cabeça de lança / Концевая секция стрелы			1,83	1,93	1,91	⑨ 270	
9	1	Laufkatze und Lasthaken / Trolley and hook / Chariot de distribution et crochet / Carrello con gancio / Carrito y gancho / Carro de ponte e gancho / Грузовая тележка и грузовой крюк			2,24	2,07	1,79	1540	
10	1	Hubwerkseinheit (65 kW) / Hoist gear unit / Treuil de levage / Gruppo meccanismo sollevamento / Mecanismo de elevación / Grupo de mecanismo elevatório / Блок грузовой лебедки			280 VZ	2,30	2,70	1,65	5850
Turm		Tower / Mât / Torre Torre / Torre / Башня							
11	10 13	Turmstück / Tower section / Élément de mât / Elemento di torre / Tramo torre / Torre / Башенная секция			355 HC 500 HC	6,28 6,28	2,45 2,45	2,45 2,45	5050 6480
12	1	Grundturmstück / Base tower section / Mât de base / Elemento di torre base / Tramo base / Peça de base de torre / Секция основания			355 HC	12,08	2,45	2,45	10050
Klettereinrichtung		Climbing equipment / Equipement de télescopage / Attrezzatura per allungamento della gru Equipo de trepado / Acesórios p. subida no edificio / Обойма наращивания							
13	1	Führungsstück kpl. / Guide section cpl. / Cage télescopique cpl. / Gabbia di sopraelevazione compl. / Torre de montaje completa / Peça de guia compl. / Направляющая секция в сб.			355 HC 500 HC	12,39	2,75	1,58	8950
14	1	Hydraulikanlage, Stütz- und Klettertraverse / Hydraulic unit, supporting and climbing cross members / Système hydraulique avec traverses d'appui et de télescopage / Sistema idraulico, traversa di appoggio e allungamento gru / Sistema hidráulico con traviesa de apoio y trepado / Instalação hidráulica, travessa de apoio e subida / Гидроагрегат, стойка-упор и траверса обоймы наращивания			355 HC 500 HC	2,10	1,10	1,00	1710
Unterwagen		Undercarriage / Châssis / Carro Carro con mástil / Carro de guindaste / Опорная рама							
15	4	Ausgleichsschwinge mit Schwingenlager / Pivot for wheel box / Chape pour bogie / Bilanciere di equilibratura con cuscinetto bilanciere / Balancin / Balancim com suporte / Балансир с шарнирной опорой			355 HC 500 HC	1,60	0,72	1,48	1390 1470
16	4	Fahrschemel mit Antrieb / Rail bogie with drive / Bogie moteur / Telaio con gruppo propulsore / Caja rodillo motriz / Quadro sem grupo de propulsão / Подрамник с приводом			355 HC 500 HC	1,40 1,45	0,75 0,82	0,65 0,72	920 1690
17	4	Fahrschemel ohne Antrieb / Rail bogie without drive / Bogie fou / Telaio senza gruppo propulsore / Caja rodillo conducido / Quadro com grupo de propulsão / Подрамник без привода			355 HC 500 HC	1,10 1,30	0,60 0,40	0,65 0,72	880 1340

Pos. Item Rep. Voce Pos. Ref. Pos.	Anz. Qty. Qte. Qta. Cant. Cant. Кол-во				L (m)	B (m)	H (m)	kg*
18	1	Tragholm lang / Long support arm / Longeron long Longherone lungo / Brazo soporte largo / Travessa comprida / Несущая балка, длинная		355 HC 500 HC	11,82 7,32	0,92 0,92	0,93 0,93	3515 2330
19	2	Tragholm kurz / Short support arm / Longeron court Longherone corto / Brazo soporte corto / Travessa curta / Несущая балка, короткая		355 HC 500 HC	5,74 7,14	0,80 0,80	0,90 0,90	1600 2135
20	4	Randträger / Border support / Traverse Supporti base / Traviesa / Apoio de bordo Стяжная балка		355 HC 500 HC	7,30 9,30	0,14 0,14	0,14 0,14	340 510
21	4	Stützholm / Support strut / Hauban de châssis Correnti di appoggio / Tirante vertical / Travessa de apoio / Опорный подкос		355 HC 500 HC	6,06 6,06	0,26 0,26	0,34 0,34	862 1140
22	1	Untervagen-Turmstück / Undercarriage tower section / Mât de châssis / Elemento di torre del carro Tramo de carro / Peça de torre do chassis Опорная башенная секция		355 HC 500 HC	6,61 6,61	2,44 2,44	2,44 2,44	7475 7930
23	1	Kiste mit Kleinteilen, Seilen / Crate with small parts, ropes Caisse contenant des accessoires, câbles / Cassa con minuteria, funi Caja con piezas pequeñas, cables / Caixa com peças pequenas, cabos Ящик с мелкими деталями, с канатами		355 HC 500 HC	2,00	1,00	1,00	1000

* **Einzelgewichte.** / Single weights. / Poids individuels. / Singoli pesi. / Pesos unitarios. / Pesos de peças componentes. / Индивидуальный вес.

Konstruktionsänderungen vorbehalten! / Subject to alterations! / Sous réserves de modifications! / Riservato il diritto di modifiche strutturali!
¡Sujeto a modificaciones! / Salvo modificação da construação! / Права на внесение конструкторских изменений сохраняются!

Sämtliche Angaben erfolgen ohne Gewähr. / This information is supplied without liability. / Ces renseignements sont sans garantie. / Tutte le indicazioni fornite senza garanzia. / Declinamos toda responsabilidad derivada de la información proporcionada. / Declinamos qualquer responsabilidade quanto à informação fornecida. / Все данные указаны без обязательств.

121 P – 4144 H1 B3 DIN 15018 • BGL C.0.10.0400 / FEM (Section 1) Krangruppe A3 • 03.07 / 7

Printed in Germany.